

# Ham Radio 'How-To' Guide

## *Windows-11 Digirig Configuration*

Mike Spohn

**N1SPW**

Revision: 1.3

2024-01-07

[www.n1spw.net](http://www.n1spw.net)

Copyright © 2023

*"If it works out of the box – what fun is that?"*

## Table of Contents

|   |    |
|---|----|
| Introduction.....   | 3  |
| 'How-To' Goal.....  | 3  |
| Step-1: Purchase a Digirig device and cable.....          | 3  |
| Step-2: <i>Obtain the right USB-C cable</i> .....         | 3  |
| Step-3: <i>Configure Windows-11 for the Digirig</i> ..... | 4  |
| Troubleshooting.....                                      | 18 |
| Wrap-Up.....  | 19 |

## Table of Figures

|   |    |
|---|----|
| Figure 1: USB-C - Pin assignments.....        | 4  |
| Figure 2: Existing devices.....               | 5  |
| Figure 3: Digirig device and port.....        | 5  |
| Figure 4: Control Panel.....                  | 6  |
| Figure 5: Playback tab.....                   | 6  |
| Figure 6: Rename sound device.....            | 7  |
| Figure 7: Renamed sound device.....           | 7  |
| Figure 8: Levels settings.....                | 8  |
| Figure 9: Enhancement settings.....           | 8  |
| Figure 10: Advanced settings.....             | 9  |
| Figure 11: Spatial sound settings.....        | 9  |
| Figure 12: Digirig is NOT Default device..... | 10 |
| Figure 13: Recording tab.....                 | 10 |
| Figure 14: Rename device to Digirig.....      | 11 |
| Figure 15: Listen tab.....                    | 11 |
| Figure 16: Custom settings.....               | 12 |
| Figure 17: Levels settings.....               | 12 |
| Figure 18: Advanced settings.....             | 13 |
| Figure 19: Digirig is NOT Default device..... | 13 |
| Figure 20: Sound setting applet.....          | 14 |
| Figure 21: Sound properties.....              | 14 |
| Figure 22: Sound input settings.....          | 15 |
| Figure 23: Input sound properties.....        | 15 |
| Figure 24: Volume Mixer.....                  | 16 |
| Figure 25: Volume Mixer settings.....         | 16 |
| Figure 26: VARA virtual sound device.....     | 17 |
| Figure 27: Listen to Digirig.....             | 18 |

## Introduction

This document is a member of the **N1SPW** 'How-To Series,' created to fill the gap between *YouTube* videos and real life. I applaud all of my Ham colleagues that have created hundreds of great videos, visualizing how to accomplish some cool Ham technology hack.

Videos are great, but, in most cases, they do not provide enough detail to get a system up and running. What seems to work without a hitch in the video, often becomes a nightmare when an average Ham attempts to recreate what they saw the presenter do.

To ease the frustration of "YouTube implementation pain" experienced by so many of us, my contribution to the Ham community is some long overdue documentation.

## 'How-To' Goal

As a Ham operator and EmComm prepper, I decided to add *Winlink* to my field capabilities. My initial goal was to get *Winlink* up and running on my HF rigs. Once that was completed, I decided to get all of my UHF/VHF HT's up and running on *Winlink HF*. This journey became a full-blown nightmare. It took me more than two weeks to get all the pieces sorted and working.

To get *Winlink* up and running, I used a *Digirig* sound device, *VARA* modem software, and a specific cable for each radio. The *Digirig* sound card has been a boon to the Ham radio community. Small, inexpensive, versatile, and dependable, the device is the true definition of "Wow-Neat." Trying to get the device configured correctly in Windows, however, can be a nightmare. This is not the fault of the device; it is the fault of Microsoft. Shame on them for designing an operating system unfit for human use.

I learned a lot in this process.

The goal of this 'How-To' is to document how to traverse the craziness of Microsoft Windows' sound device configuration, to work with the *Digirig*. Hopefully, this will save other Hams some time and frustration. This document focuses on Windows 11 sound card configuration. There is a companion document that covers Windows 10. The details of specific rig configurations is in other 'How-To' documents.

## Step-1: Purchase a Digirig device and cable

The first step is to get your hands on a *Digirig* device and the proper cable(s) for your rig(s). You can purchase them directly from [Digirig](#) or on [Amazon](#). They are cheaper if you order them direct from *Digirig*.

## Step-2: Obtain the right USB-C cable

One thing I learned the hard way; finding the right USB-C cable can be a challenge.

Not all USB-C cables are the same. They can be internally wired very differently. Some are designed to only charge a USB device. These cables will only have the power pins connected. They will not work with the *Digirig*. Others have very complicated wiring to support the Thunderbolt protocol. Also, the wire quality and shielding vary greatly.

Figure 1 below show the complexity of a USB-C cable. The top and bottom connectors are redundant so you can plug the cable in without regard to orientation. It is important to understand, vendors will wire a cable for specific purposes and devices. This is why not all USB-C cables will work with your *Digirig*.

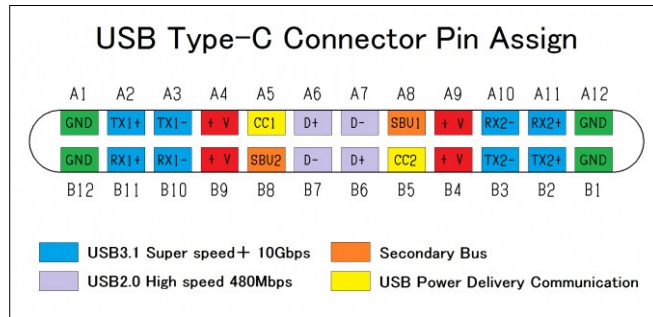

Figure 1: USB-C - Pin assignments

[https://pinoutguide.com/Slots/usb-type-c\\_pinout.shtml](https://pinoutguide.com/Slots/usb-type-c_pinout.shtml)

**Free Advice:** Beware of cheap USB-C cables manufactured in China.

I, like most people, have a bunch of USB-C cables lying around. Many of them did not work with the *Digirig*. This can be a serious trap for the unsuspecting troubleshooter. I had to try several different cables before I found a couple that worked.

I can give you an example of the kind of trouble the wrong USB cables can cause. I was testing one of my HT's to send *Winlink* Emails using the *Vara FM* modem. The *Digirig* would trigger the PTT signal and the HT went into xmit mode. The end xmit signal from the *Digirig* never arrived at the HT, so the HT was stuck in xmit mode. I spent hours trying to fix the problem in Windows and on the HT. In desperation, I tried a different USB cable and the problem went away.

It is best to keep your USB-C cables short. I also suggest you add a pair of [chokes](#) to the USB cables you use.

To save yourself some trouble, you can buy a known good USB-C cable with chokes directly from [Digirig](#).

**Free Advice:** DO NOT underestimate the problems lousy USB cables can cause.

### Step-3: Configure Windows-11 for the Digirig

In this step, I walk you through the crazy way you have to configure your *Digirig* in Windows 11. Do not plug your *Digirig* into you computer yet. If it is already connected, disconnect it.

There are three (3) configuration locations you need to visit to configure your *Digirig*.

1. Device Manager
2. Control Panel
3. Sound Settings

#### Device Manager

Press the Windows key and enter 'Device' in the search bar. You should see an icon for the 'Device Manager'. Click on the link to open it.

Drop down the 'Sound, video, and game controllers' lists. This will show you the *existing* sound devices and assigned serial ports. (Figure 2). There is no 'Serial Ports' section in my list because I have no serial devices attached to the computer.

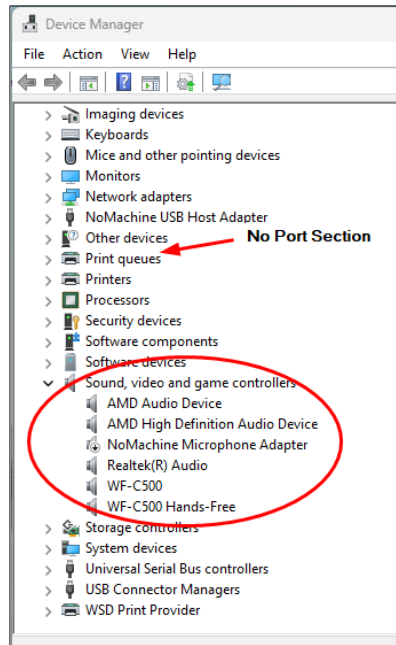

Figure 2: Existing devices

Now, plug in your *Digirig*. You should see a sound card entry added to the sound controller list, and a serial port assigned to a new sound device. As shown below in Figure 3, a new sound controller named 'USB PnP Sound Device' was added to the sound controller list, and serial port 6 (COM6) has been assigned to a new serial device named, 'Silicon Labs CP210x USB to UART Bridge'. This information tells you that Windows detected the *Digirig* and assigned it the proper driver. Make note of the Com port (COM6) if you plan on using the *Digirig* PTT feature.

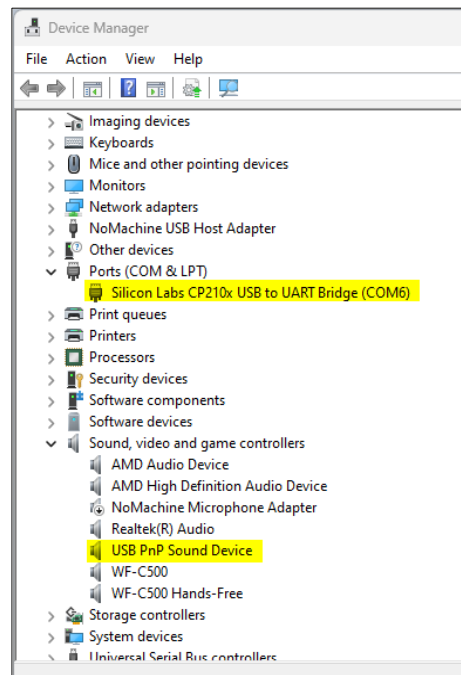

Figure 3: Digirig device and port

## Control Panel

The next step is the Windows 'Control Panel'. Press the Windows key and enter 'Control Panel' in the search bar. When the *Control Panel* icon appears, click on the link to open it. In the upper right corner, select 'View By | Small icons' to see the full list of applets. Then click on the 'Sound' applet icon (Figure 4).

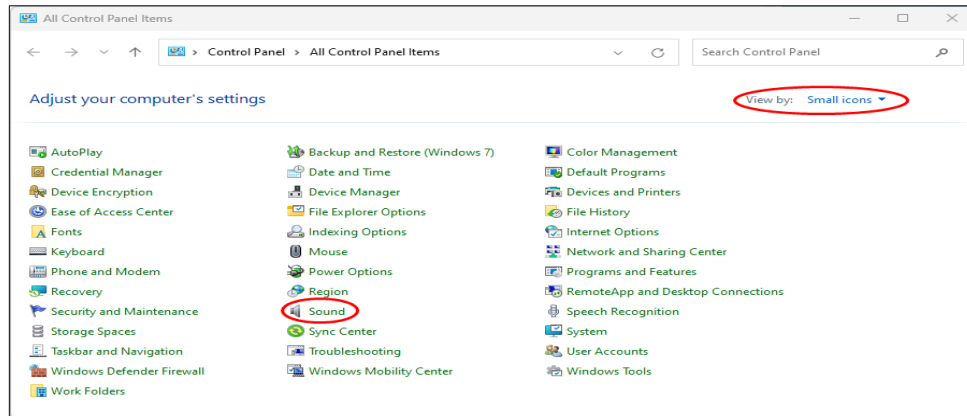

Figure 4: Control Panel

When the Sound applet opens, click on the 'Playback' tab, then click on the 'USB PnP Sound Device.' Then click on the 'Properties' button (Figure 5).

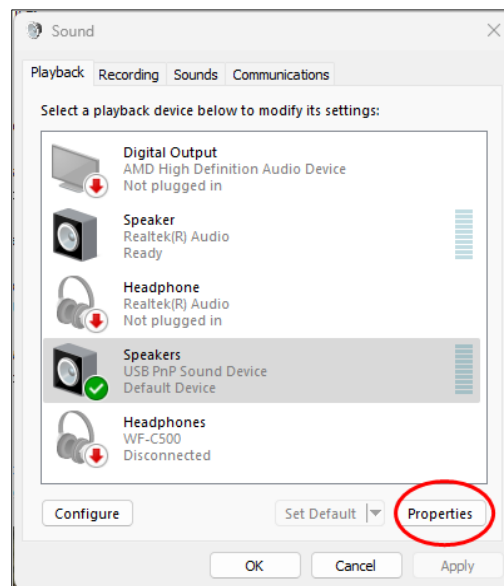

Figure 5: Playback tab

Select the 'General' tab. Here we want to rename the device and change the icon so the *Digirig* is easy find later in the sound applets (Figure 6).

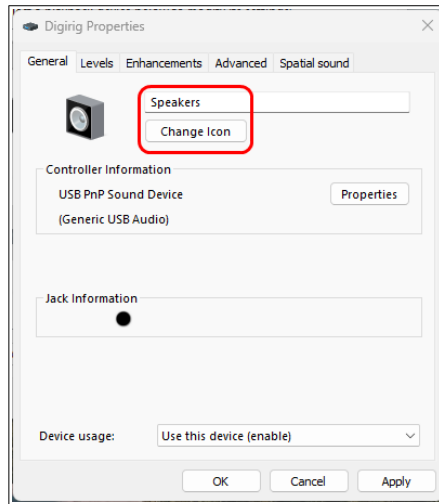

Figure 6: Rename sound device

Rename the device from "Speakers" to "Digirig". Next, click on the 'Change Icon' button and change the icon to the modem image (Figure 7).

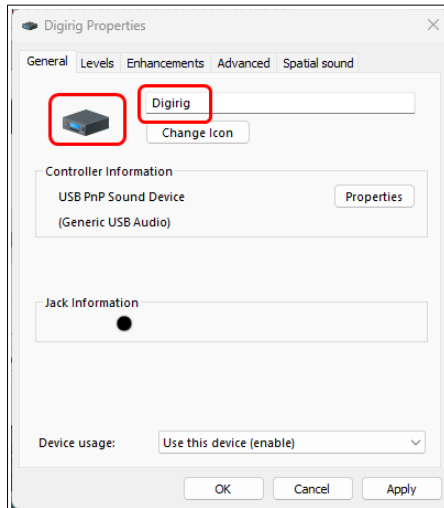

Figure 7: Renamed sound device

Click on the 'Levels' tab. Set the 'Speakers' volume setting in the lower range. As in all things radio, only use the required power to get the job done. You can always add more later as needed.

Make sure the Microphone setting is zero '0' and the setting is disabled (Figure 8). Click 'Apply'.

**Note:** Be sure the microphone setting is disabled or it will cause you lots of headaches.

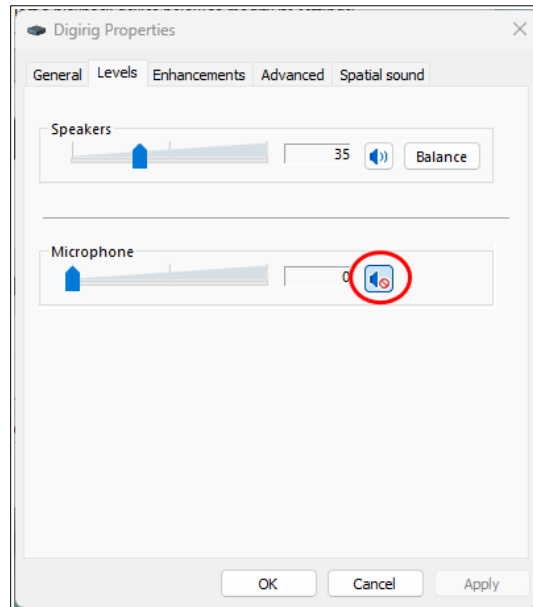

Figure 8: Levels settings

Click on the 'Enhancements' tab. Be sure the 'Disable all enhancements' checkbox is checked (Figure 9).

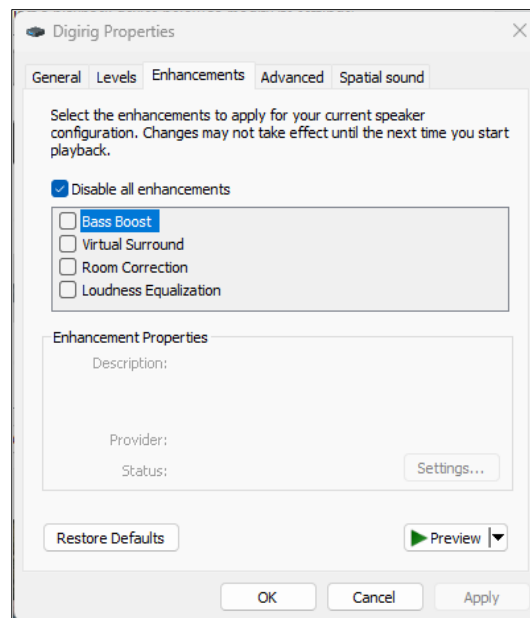

Figure 9: Enhancement settings



Click on the 'Advanced' tab. No changes are needed here (Figure 10).

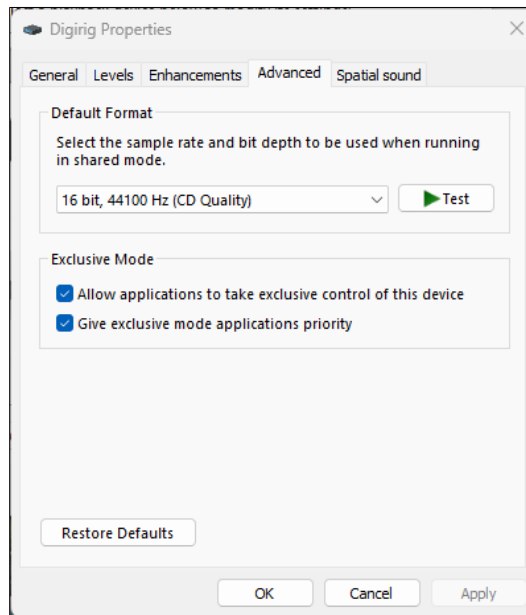

Figure 10: Advanced settings

Click on the 'Spatial sound' tab. Be sure that all spacial sounds are turned off (Figure 11).

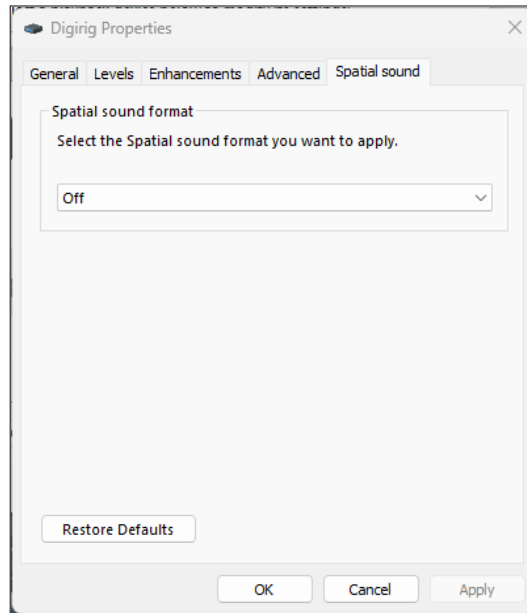

Figure 11: Spatial sound settings

Now that the Sound settings are in place, click on the 'OK' button to return to the main Sound applet.

It is important to make sure the *Digirig* **is not** the 'Default' sound device. Click on your system 'Speaker' icon and click the 'Set Default' button (Figure 12). If you do not have speakers connected to your computer, make any other device in the list the 'Default' device.

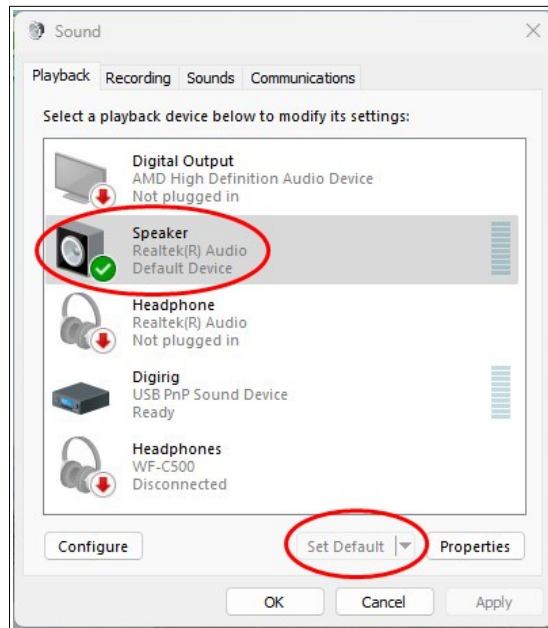

Figure 12: Digirig is NOT Default device

Next, click on the 'Recording' tab. Select the 'Microphone' associated with the 'USB PnP Sound Device'. Click the *Properties* button (Figure 13).

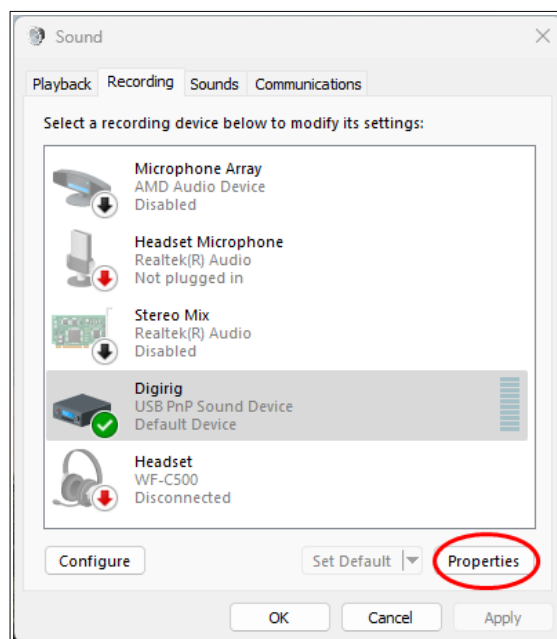

Figure 13: Recording tab

In the 'General' tab, rename the device to *Digirig* and change the icon to the modem icon (Figure 14).

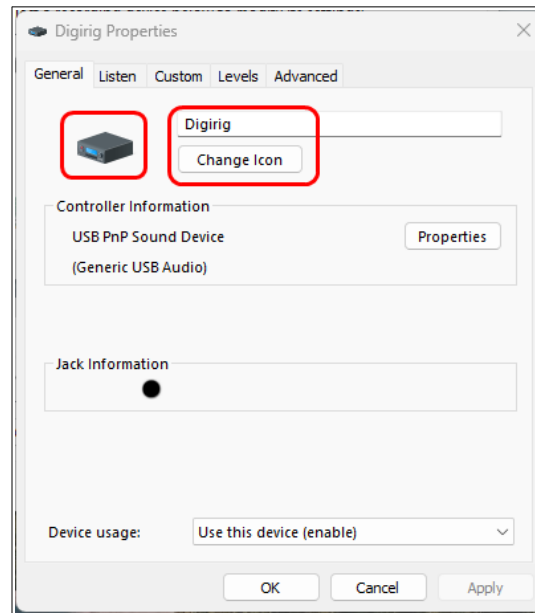

Figure 14: Rename device to Digirig

Click on the 'Listen' tab. The 'Listen to this device' checkbox can be used for troubleshooting should the need arise. This allows you to listen to the Digirig input through your system speakers. For now, leave the box unchecked. Make sure the 'Continue running when on battery power' radio button IS checked if you plan on using your computer in the field (Figure 15).

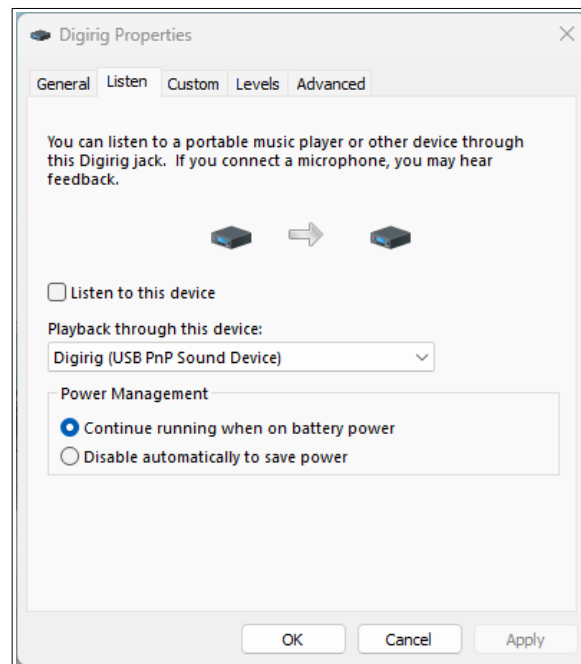

Figure 15: Listen tab

Click on the 'Custom' tab. Make sure the AGC (Automatic Gain Control) button **is not** checked (Figure 16),

**Note:** This is an important setting. It has caused many Hams all kinds of headaches. If you leave it checked, Windows will mess with your *Digirig* microphone gain setting behind your back. This will drive you crazy.

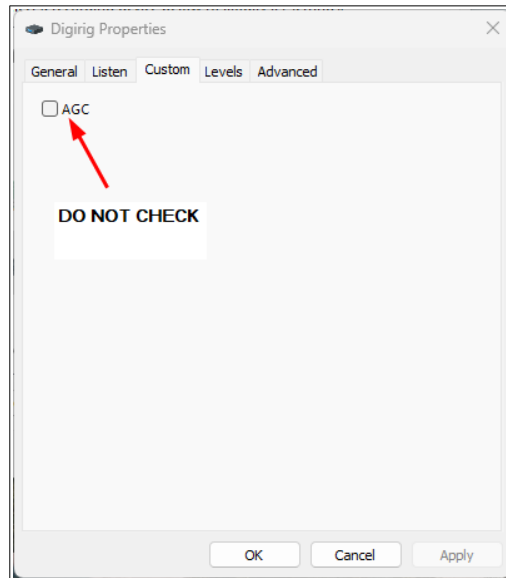

Figure 16: Custom settings

Click on the 'Levels' tab. Move the microphone level to the lower 1/3 of the range (Figure 17).

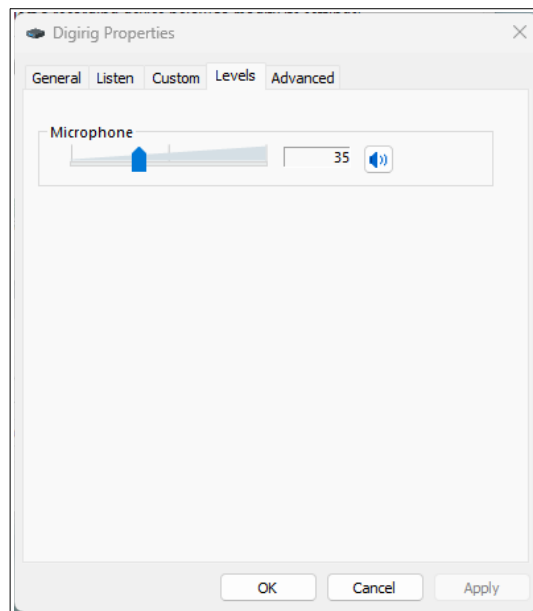

Figure 17: Levels settings

Click on the 'Advanced' tab. No changes are needed here (Figure 18).

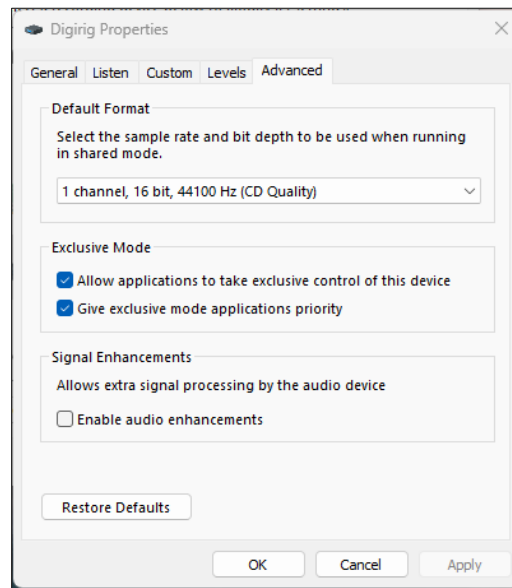

Figure 18: Advanced settings

Click the 'OK' button to return to the main Sound applet.

Make sure the *Digirig* is **not** the 'Default' recording device. Click on your system microphone icon and then click on the 'Set Default' button. If you do not have a microphone on your system make any other device in the list the 'Default Device.'

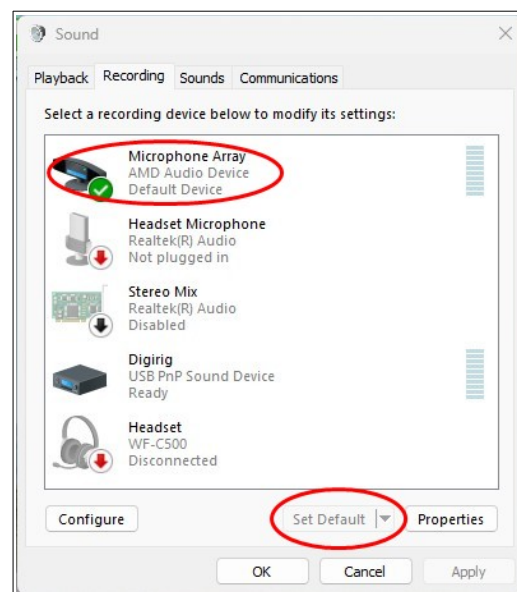

Figure 19: Digirig is NOT Default device

There is no need to change anything in the 'Sounds' or 'Communications' tabs. Click 'OK' to exit the applet.

## Sound Settings

One of the most critical success factors with a *Digirig*, is ensuring the sound levels are correct for the rig you are using. The signals must be precise and the PTT feature must open and close the microphone instantly. There are many ways to adjust sound levels. There is a “Sound Settings” applet you can find by pressing the Windows key and typing ‘Sound’ in the search box. Then click on the applet link. The ‘System > Sound’ dialog appears. (Figure 20).

In the Output section of the dialog, click on the right arrow symbol associated with the *Digirig* device.

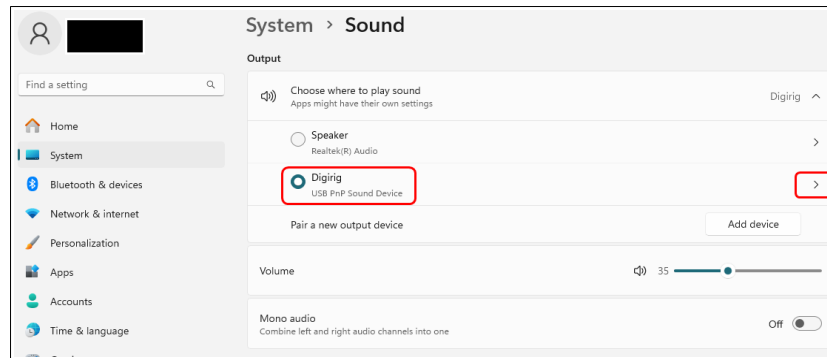

Figure 20: Sound setting applet

This will open the ‘Properties’ dialog (Figure 21).

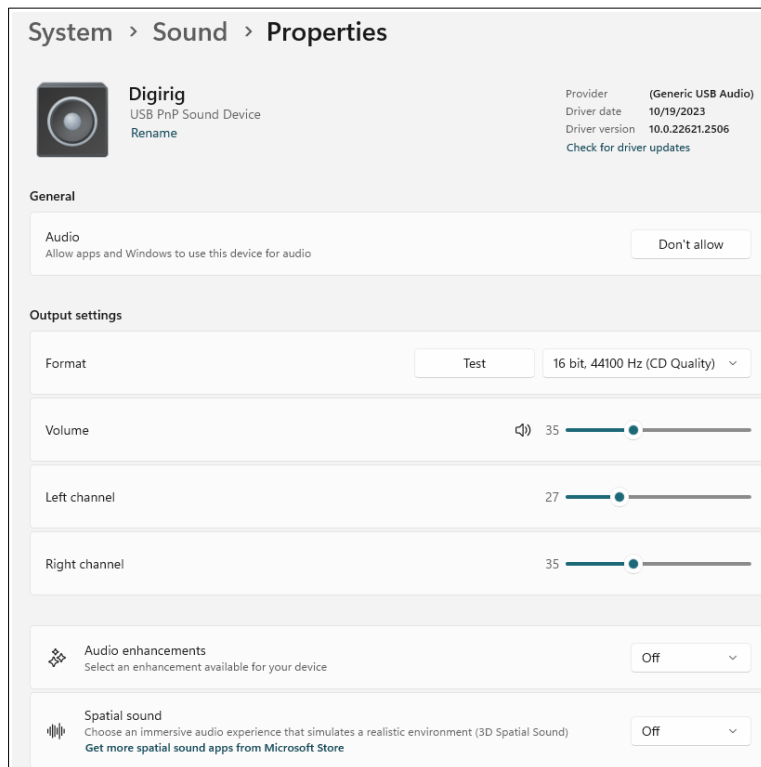

Figure 21: Sound properties

Make sure your settings match Figure 21. ‘Audio enhancements’ and ‘Spatial sound’ should be set to off.

Go back to the base Sound dialog and focus on the 'Input' section at the bottom. Make sure the input device is set to 'Digirig'. Next, click on the right arrow to open the input settings dialog (Figure 22).

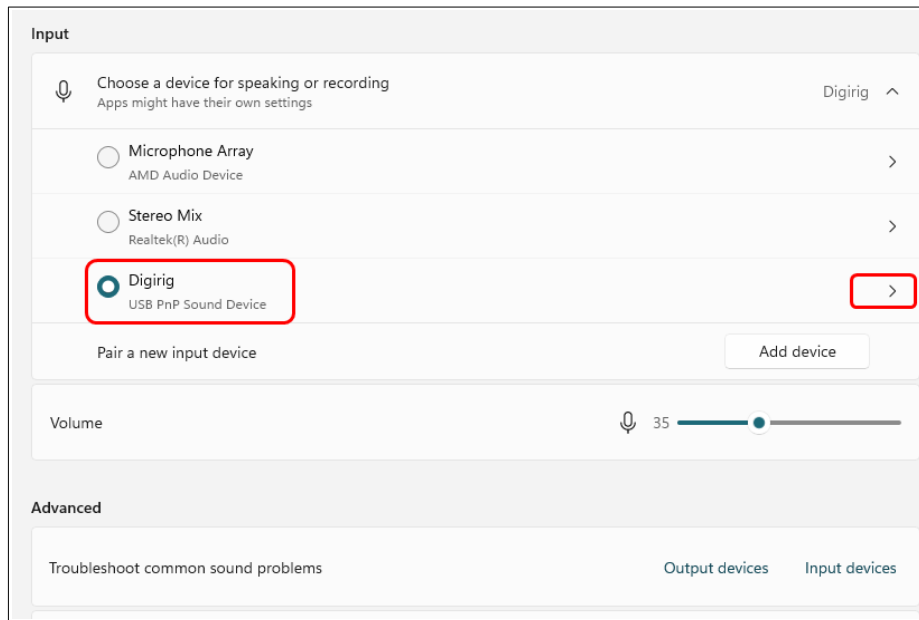

Figure 22: Sound input settings

When the input properties dialog opens, make sure your setting match Figure 23 below. Audio enhancements should be set to off.

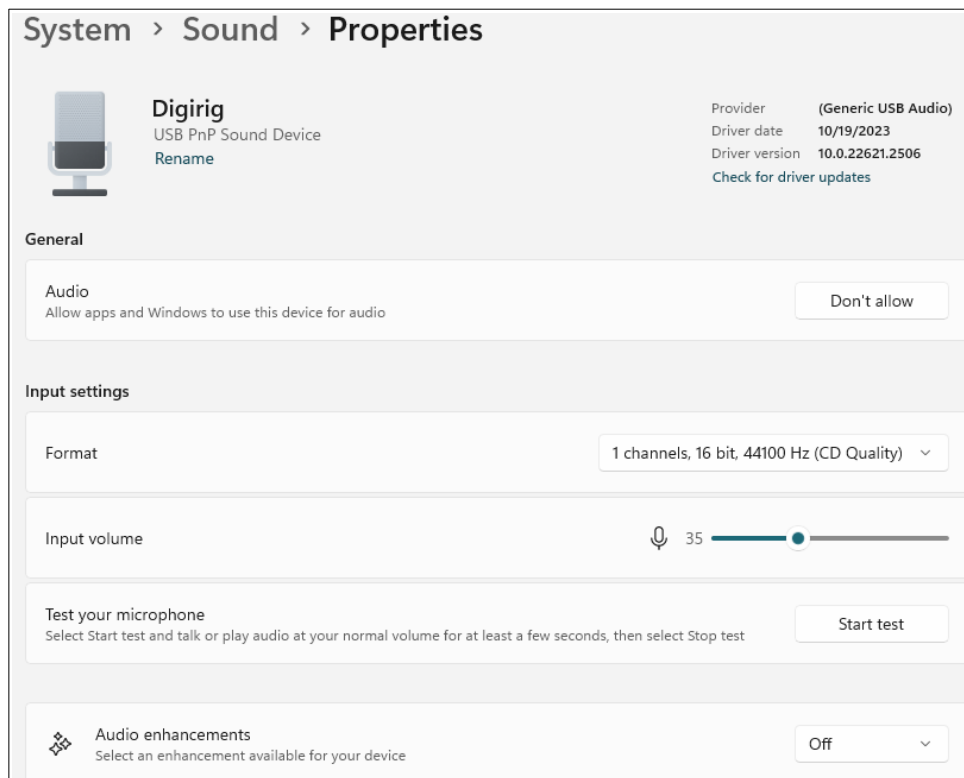

Figure 23: Input sound properties

There is one more tool at your disposal that is quite useful – the ‘Volume Mixer’. You can find it in the lower section of the Sound Settings applet base screen under the ‘Advanced section’ (Figure 24).

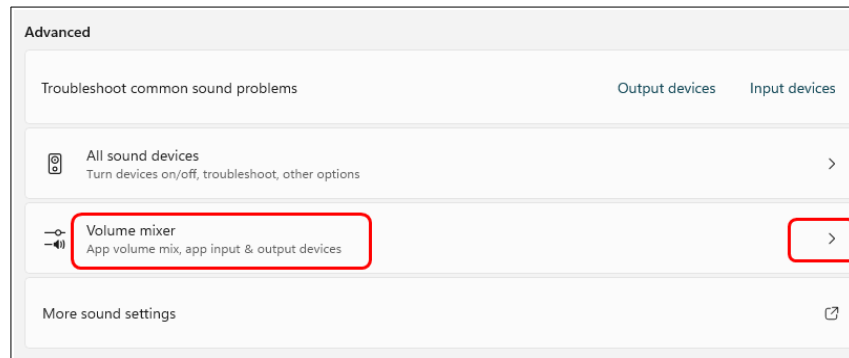

Figure 24: Volume Mixer

The ‘Volume Mixer’ settings are shown below in Figure 25. Notice the *Digirig* is set as the ‘System’ Output and Input device.

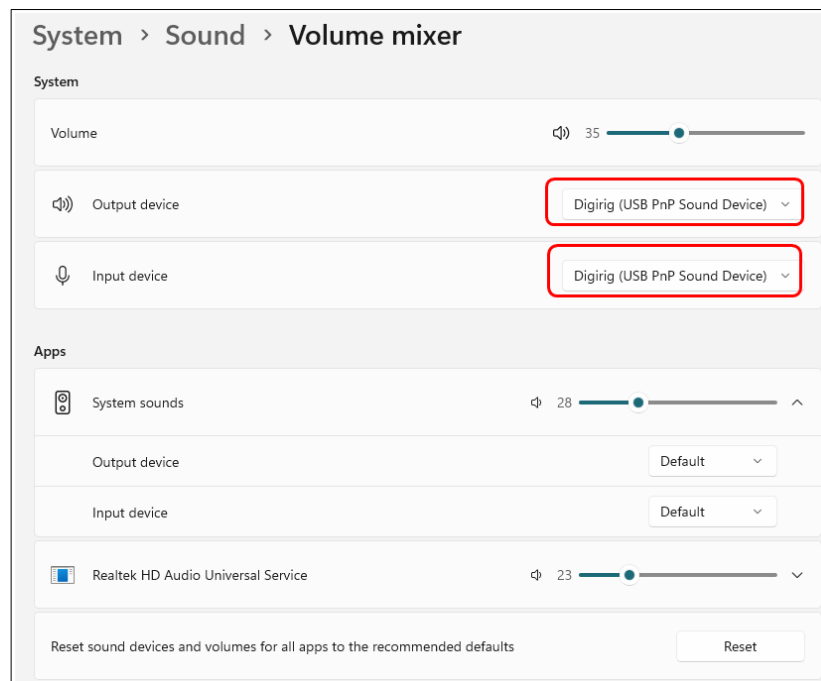

Figure 25: Volume Mixer settings

There is one more thing to consider. Additional sound devices may show up when you start some applications. When I start *Winlink* and the open a *Vara* session, a VARA device shows up (Figure 26).



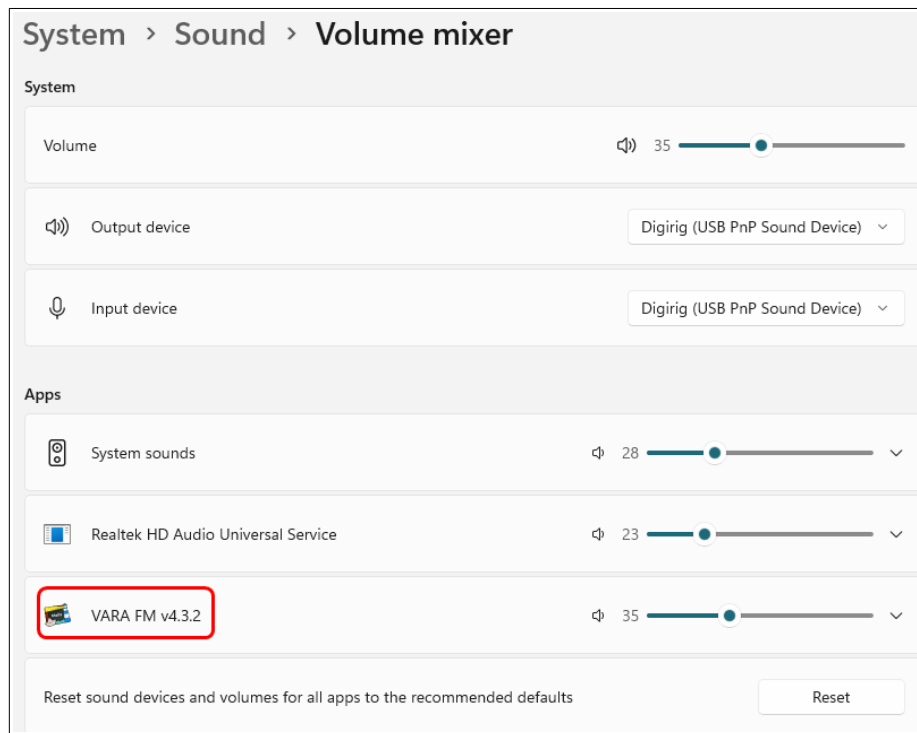

Figure 26: VARA virtual sound device

Be sure to look for these devices, depending on the apps you run. You can adjust their sound settings just like you can with the *Digirig*.

### Rig Settings

Once you set the basic configuration items for your *Digirig*, you will need to get it to work with your radio. This task is beyond the scope of this document. I will cover rig configuration in future ‘How-To’s’. This can be pretty simple, but often it can get complicated fast.

The *Digirig* has the capability to control your rigs microphone using a serial signal accepted by most radios on their data port. You will need the correct cable from *Digirig*. You will also need to tell your Ham application (e.g. Vara) what Comm port to use for PTT control.

## Troubleshooting

Getting a *Digirig* connected to work with Windows-11 is not difficult. The Windows native device driver *usually* will recognize the device. The steps above should help you ensure the *Digirig* is recognized by Windows. It also shows you the many places in Windows you need to know about to adjust audio settings.

**Free Advice:** If your *Digirig* is not recognized by Windows, do not blame the *Digirig*. The failure rate on modern electronic devices is very low. Do not fall into the trap of believing the *Digirig* is broken. Look for the problem elsewhere.

What do you do if Windows does not recognize the Digirig?

1. *Try a different USB-C cable.*  
Step-2 describes why USB-C cables are not all alike and can cause lots of headaches for you.
2. *Try a different USB port.*  
USB port types can vary on a computer. Plug your Digirig into a different USB port to see if Windows recognizes it.
3. *Reboot Windows.*  
This is always the advice you get from the “Help-Desk, ” but it often works.
4. *Try a different computer.*  
If you have access to another computer, see if the *Digirig* will work on it. This will help determine if the problem is specific to a computer.
5. Look for help on the [Digirig support forum](#).  
There is good advice here. In particular, [read this page](#) closely.

Another trick is to direct the feed from VARA or the *Digirig* to your system speakers. To listen to the Digirig input, open up ‘Control Panel | Sound’ settings. Click on the ‘Recording’ tab. Select the *Digirig*. Click on the ‘Recording’ tab. Finally, select the ‘Listen’ tab.

Check the ‘Listen to this device’ and select your system speakers in the dropdown list. (Figure 27). Click OK. You can now hear the radio through your speakers.

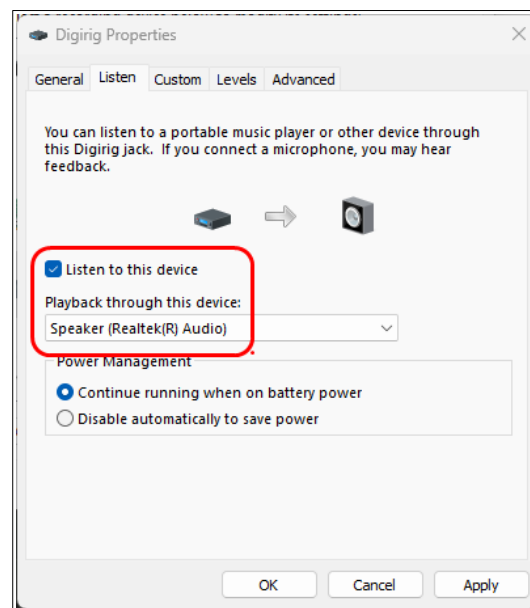

Figure 27: Listen to Digirig

## **Wrap-Up**

I hope you find this guide useful and that it helps you navigate the craziness of Windows sound settings.

I do not consider myself an expert in all things *Digirig*. My intent here is to provide some detailed, visual, documentation, to help new Hams or those do have little patience for the complications of technology.

Send corrections, comments, complaints, ideas, or any other feedback to: [n1spw@arrl.net](mailto:n1spw@arrl.net) .

73,  
**N1SPW**  
Jan 7, 2024